

## January 2017 Update Pack

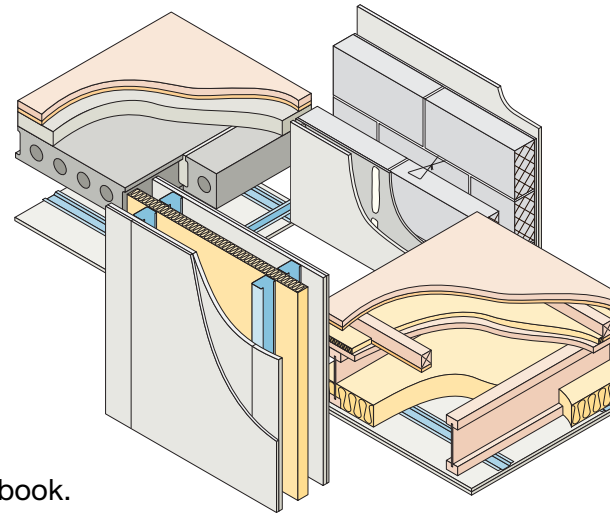

Dear Colleague,

This is the first 2017 update to the Part E Robust Details Handbook.

In this update pack, we have focussed on clarifying the situation on incorporating underfloor heating (UFH) in certain separating floors.

E-FC-1, E-FC-2 and E-FS-1 specify that where the FFT4 and FFT5 overlay platform systems were used, services cannot be installed in the floor system. This is to guard against sections of the resilient layer being cut away to accommodate pipes etc. – something that is still very relevant, and which must be avoided. However, where UFH in the form of pipes in a routed board layer is used, this can be placed directly below the FFT; or (as noted in this update) it can be included as an additional layer within the thickness of the FFT provided all the components have been tested, as a composite, in accordance with Appendix D.

Don't forget that if you still have a hardcopy Handbook, please feel free to print off this pack (double-sided if you can), and insert the pages in your Handbook as described below.

### **Please update your September 2016, 4th Edition Handbook as follows:**

1. Remove and replace the last leaf (pages 7-8) of E-WT-2.
2. Remove and replace the second leaf (pages 3-4) of E-FC-1.
3. Remove and replace the third leaf (pages 5-6) of E-FC-2.
4. Remove and replace the second leaf (pages 3-4) of E-FS-1.
5. Remove and replace pages 7 and 8 of Appendix A1.

Yours sincerely

A handwritten signature in black ink, appearing to read 'John Tebbit', written over a horizontal line.

**John Tebbit**

Chief Executive,  
Robust Details Limited





# Changes to the fourth edition following January 2017 update

---

Section Page Amendment

## Separating Wall – Timber

### E-WT-2

---

Diagram 10 7 Options 10.1 and 10.2 were referenced as 9.1 and 9.2.

## Separating Floor – Concrete

### E-FC-1

---

Floating floor treatments 4 Use of underfloor heating in FFT4 and FFT5 clarified.

### E-FC-2

---

Floating floor treatments 5 Use of underfloor heating in FFT4 and FFT5 clarified.

## Separating Floor – Steel-concrete composite

### E-FS-1

---

Floating floor treatments 4 Use of underfloor heating in FFT4 and FFT5 clarified.

## Appendix A1

Underfloor heating 8 Use of underfloor heating in FFT4 and FFT5 clarified.



## 10. Services and sockets in the separating wall

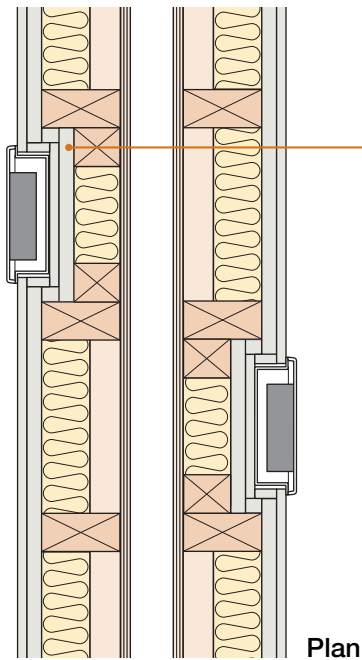

### 10.1 – electrical sockets, switches, etc.

Provide two or more layers of gypsum-based board (total nominal mass per unit area 22 kg/m<sup>2</sup>) to enclose electrical boxes

Stagger sockets, switches, etc. on each side of the wall such that they are not positioned in opposite bays

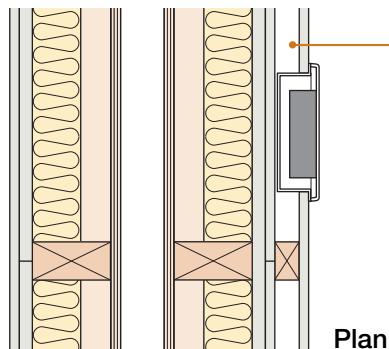

Alternatively provide a service void on surface of separating wall. This is the preferred method where more than one socket, switch, etc. are close together, e.g. in a kitchen.

Studs or battens used to create the service zone should be securely fixed back to the separating wall structure

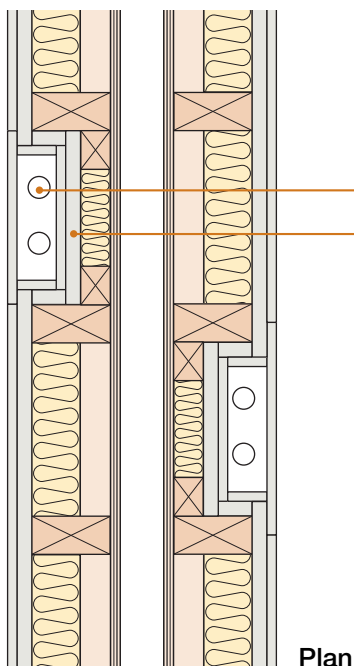

### 10.2 – piped services

Service duct within separating wall

Provide two or more layers of gypsum-based board (total nominal mass per unit area 22 kg/m<sup>2</sup>) to enclose pipes

Stagger services on each side of wall such that they are not positioned in opposite bays

Note: this detail is not applicable for SVPs or gas pipes.

CHECKLIST (to be completed by site manager/supervisor)

Company: \_\_\_\_\_

Site: \_\_\_\_\_

Plot: \_\_\_\_\_ Site manager/supervisor: \_\_\_\_\_

Ref.	Item	Yes (✓)	No (✓)	Inspected (initials & date)
1.	Are wall linings at least 240mm apart?	<input type="checkbox"/>	<input type="checkbox"/>	<input type="text"/>
2.	Are sheathing boards at least 50mm apart?	<input type="checkbox"/>	<input type="checkbox"/>	<input type="text"/>
3.	Is absorbent material at least 60mm thick?	<input type="checkbox"/>	<input type="checkbox"/>	<input type="text"/>
4.	Does absorbent material cover whole lining area except above ceiling line in roof void zone?	<input type="checkbox"/>	<input type="checkbox"/>	<input type="text"/>
5.	Are all joints in wall lining staggered?	<input type="checkbox"/>	<input type="checkbox"/>	<input type="text"/>
6.	Is separating wall lining correct mass per unit area on both sides?	<input type="checkbox"/>	<input type="checkbox"/>	<input type="text"/>
7.	Are all joints sealed with tape or caulked with sealant?	<input type="checkbox"/>	<input type="checkbox"/>	<input type="text"/>
8.	Are services installed in accordance with sketches 10.1 and 10.2?	<input type="checkbox"/>	<input type="checkbox"/>	<input type="text"/>
9.	If there is a separating floor (e.g. in flats/apartments) has the resilient flanking strip been provided?	<input type="checkbox"/>	<input type="checkbox"/>	<input type="text"/>
10.	Is separating wall satisfactorily complete?	<input type="checkbox"/>	<input type="checkbox"/>	<input type="text"/>

Notes (include details of any corrective action)

Site manager/supervisor signature .....

©: UK registered trade mark no. 2291665

© Robust Details Limited 2011. All rights reserved. No part of this Handbook (other than the checklists) may be reproduced in any material form or issued or communicated to the public (including photocopying or storing it in any medium by electronic means, and whether or not transiently or incidentally to some other use of this Handbook) without the prior written permission of Robust Details Limited except in accordance with the provisions of the Copyright, Designs and Patents Act 1988.

Warning: the doing of an unauthorised act in relation to a copyright work may result in both a civil claim for damages and criminal prosecution.

## 3. Ceiling treatments for E-FC-1

All ceiling treatments must be installed in accordance with the manufacturer's instructions. All ceiling joints must be sealed with tape or caulked with sealant.

The maximum load on resilient bars shall not exceed that specified in the manufacturer's instructions.

Note: the sound insulation performance of all ceiling treatments is increased if:

- 25mm (min) mineral wool quilt is placed in the ceiling void, and/or
- resilient hangers are used.

### Downlighters and recessed lighting

Provided there is a minimum ceiling void of 75mm downlighters or recessed lighting may be installed in the ceiling:

- in accordance with the manufacturer's instructions
- at no more than one light per 2m<sup>2</sup> of ceiling area in each room or see Appendix F
- at centres not less than 0.75m
- into openings not exceeding 100mm diameter or 100x100mm

Particular attention should also be paid to Building Regulations Part B - Fire Safety

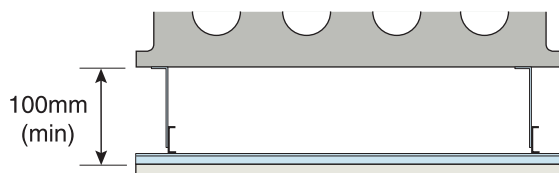

### CT1 – Metal ceiling system - 100mm void

- any metal ceiling system providing 100mm (min) ceiling void
- one layer of nominal 8 kg/m<sup>2</sup> gypsum-based board

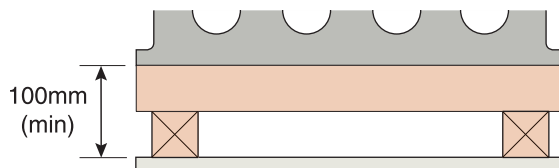

### CT2 – Timber battens and counterbattens

- 50 x 50mm softwood battens
- 50 x 50mm counterbattens
- one layer of 8 kg/m<sup>2</sup> gypsum-based board

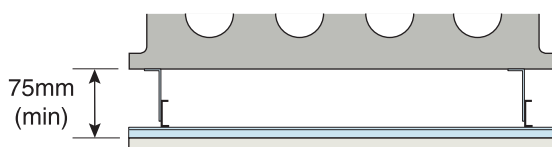

### CT3 – Metal ceiling system - 75mm void

- any metal ceiling system providing 75mm (min) ceiling void
- one layer of nominal 10 kg/m<sup>2</sup> gypsum-based board

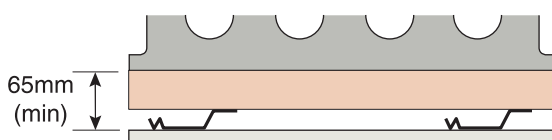

### CT4 – Timber battens and metal resilient bars

*Only suitable for use in conjunction with 200mm (min) precast concrete floor plank of mass per unit area 300 kg/m<sup>2</sup> (min).*

- 50 x 50mm softwood battens
- metal resilient ceiling bars mounted at right angles to the battens (bars must achieve a minimum laboratory performance of  $rd\Delta R_w + C_{tr} = 17\text{dB}$  and  $rd\Delta L_w = 16\text{dB}$ ) - see Appendix E
- one layer of minimum nominal 10 kg/m<sup>2</sup> gypsum-based board

## 4. Floating floor treatments for E-FC-1

All floating floor treatments :

- Must achieve a minimum laboratory performance of  $rd\Delta L_w = 17\text{dB}$  - see Appendix D.
- Must be installed in accordance with the manufacturer's instructions.
- Require 5mm (min) resilient flanking strips around the perimeter of the flooring board to isolate floor from walls and skirting.

d) For further guidance on floating floor treatments and flanking strips, please refer to Appendix A.

\* Note - void dimensions indicated are when floor is loaded to 25 kg/m<sup>2</sup>.

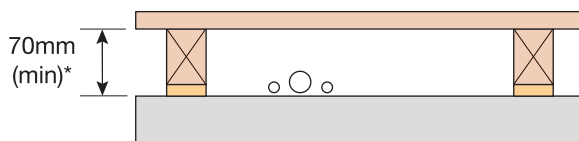

### FFT 1 – Resilient composite deep batten system

- 18mm (min) t&g flooring board
- resilient layer must be continuous and pre-bonded to batten
- resilient composite deep battens
- ensure any services do not bridge the resilient layer
- battens may have the resilient layer at the top or the bottom

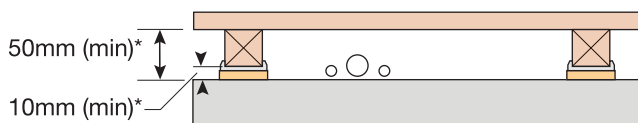

### FFT 2 – Resilient cradle and batten system

- 18mm (min) t&g flooring board
- cradle and batten
- ensure any services do not bridge the resilient layer

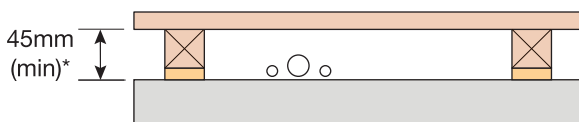

### FFT 3 – Resilient composite standard batten system

- 18mm (min) t&g flooring board
- resilient layer must be continuous and pre-bonded to batten
- resilient composite standard battens
- ensure any services do not bridge the resilient layer
- battens may have the resilient layer at the top or the bottom

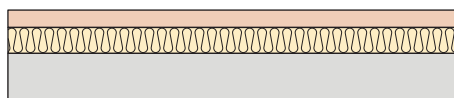

### FFT 4 – Resilient overlay platform floor system

- proprietary platform system inclusive of resilient layer greater than or equal to 16 kg/m<sup>2</sup> mass per unit area
- no services to be installed in floor system\*



### FFT 5 – Resilient overlay shallow platform floor system

- 9mm (min) t&g flooring board
- resilient layer pre-bonded to flooring board
- no services to be installed in floor system\*

\* Additional under floor heating layers may be incorporated within FFT4 and FFT5 provided the complete build-up, using all components, has been tested to give a minimum laboratory performance of  $rd\Delta L_w = 17\text{dB}$  - see Appendix D.



## 5. Floating floor treatments for E-FC-2

All floating floor treatments :

- Must achieve a minimum laboratory performance of  $rd\Delta L_w = 17\text{dB}$  - see Appendix D.
- Must be installed in accordance with the manufacturer's instructions.
- Require 5mm (min) resilient flanking strips around the perimeter of the flooring board to isolate floor from walls and skirting.

d) For further guidance on floating floor treatments and flanking strips, please refer to Appendix A.

\* Note - void dimensions indicated are when floor is loaded to 25 kg/m<sup>2</sup>.

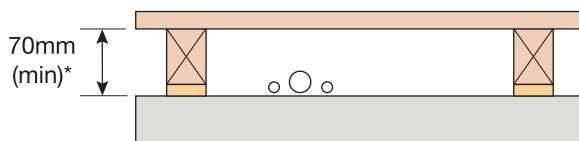

### FFT1 – Resilient composite deep batten system

- 18mm (min) t&g flooring board
- resilient layer must be continuous and pre-bonded to batten
- resilient composite deep battens
- ensure any services do not bridge the resilient layer
- battens may have the resilient layer at the top or the bottom

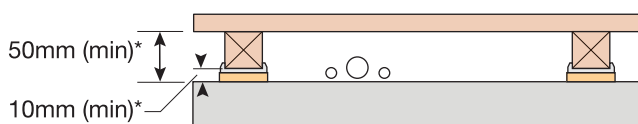

### FFT2 – Resilient cradle and batten system

- 18mm (min) t&g flooring board
- cradle and batten
- ensure any services do not bridge the resilient layer

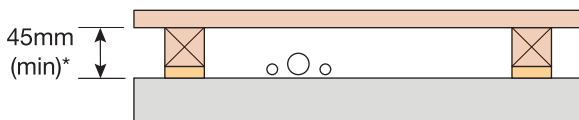

### FFT3 – Resilient composite standard batten system

- 18mm (min) t&g flooring board
- resilient layer must be continuous and pre-bonded to batten
- resilient composite standard battens
- ensure any services do not bridge the resilient layer
- battens may have the resilient layer at the top or the bottom

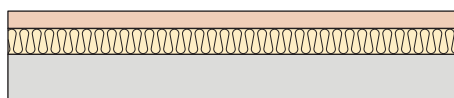

### FFT4 – Resilient overlay platform floor system

- proprietary platform system inclusive of resilient layer greater than or equal to 16 kg/m<sup>2</sup> mass per unit area
- no services to be installed in floor system\*

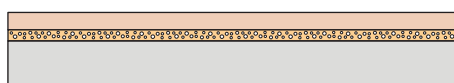

### FFT5 – Resilient overlay shallow platform floor system

- 9mm (min) t&g flooring board
- resilient layer pre-bonded to flooring board
- no services to be installed in floor system\*

\* Additional under floor heating layers may be incorporated within FFT4 and FFT5 provided the complete build-up, using all components, has been tested to give a minimum laboratory performance of  $rd\Delta L_w = 17\text{dB}$  - see Appendix D.

## 6. Services – Service pipes through separating floor

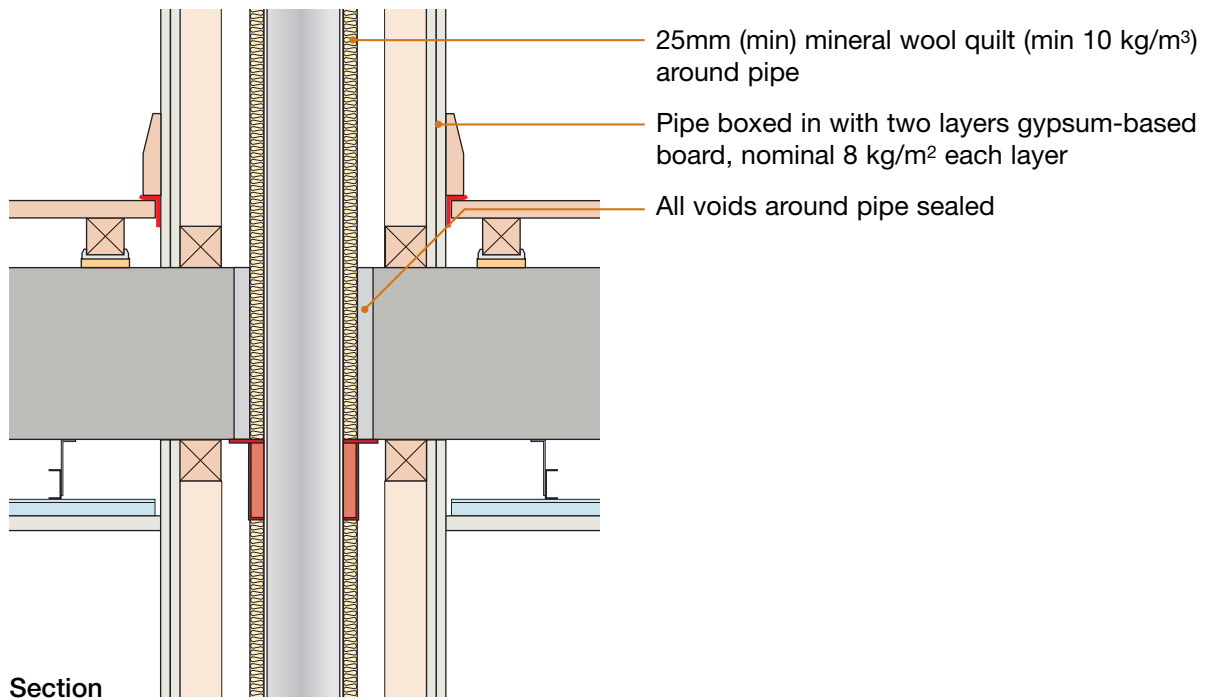

Sketch shows FFT2 type floating floor treatment and metal ceiling treatment

## 3. Ceiling treatment for E-FS-1

Ceiling treatment must be installed in accordance with the manufacturer's instructions

All ceiling joints must be sealed with tape or caulked with sealant

The maximum load on resilient bars shall not exceed that specified in the manufacturer's instructions

Note: the sound insulation performance of ceiling treatment is increased if:

- 25mm (min) mineral wool quilt is placed in the ceiling void, and/or
- resilient hangers are used

### Downlighters and recessed lighting

Provided there is a minimum ceiling void of 75mm downlighters or recessed lighting may be installed in the ceiling:

- in accordance with the manufacturer's instructions
- at no more than one light per 2m<sup>2</sup> of ceiling area in each room or see Appendix F
- at centres not less than 0.75m
- into openings not exceeding 100mm diameter or 100x100mm

Particular attention should also be paid to Building Regulations Part B - Fire Safety

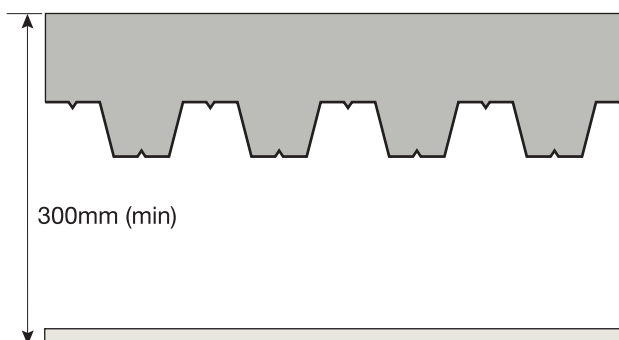

### Any ceiling system

- one layer of nominal 8 kg/m<sup>2</sup> gypsum-based board

## 4. Floating floor treatments for E-FS-1

All floating floor treatments :

- Must achieve a minimum laboratory performance of  $rd\Delta L_w = 17\text{dB}$  - see Appendix D.
- Must be installed in accordance with the manufacturer's instructions.
- Require 5mm (min) resilient flanking strips around the perimeter of the flooring board to isolate floor from walls and skirting.

d) For further guidance on floating floor treatments and flanking strips please refer to Appendix A.

\* Note - void dimensions indicated are when floor is loaded to  $25\text{ kg/m}^2$ .

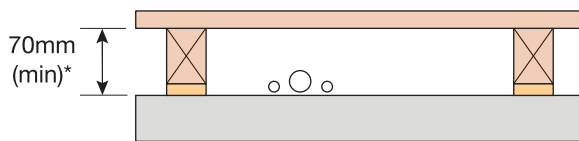

### FFT 1 – Resilient composite deep batten system

- 18mm (min) t&g flooring board
- resilient layer must be continuous and pre-bonded to batten
- resilient composite deep battens
- ensure any services do not bridge the resilient layer
- battens may have the resilient layer at the top or the bottom

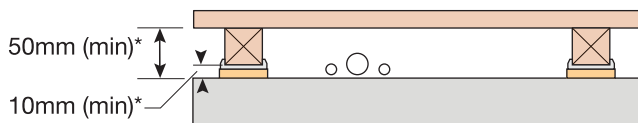

### FFT 2 – Resilient cradle and batten system

- 18mm (min) t&g flooring board
- cradle and batten
- ensure any services do not bridge the resilient layer

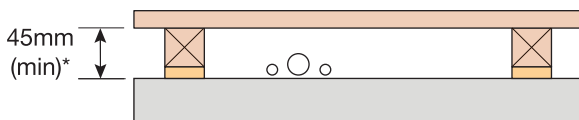

### FFT 3 – Resilient composite standard batten system

- 18mm (min) t&g flooring board
- resilient layer must be continuous and pre-bonded to batten
- resilient composite standard battens
- ensure any services do not bridge the resilient layer
- battens may have the resilient layer at the top or the bottom

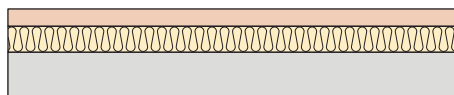

### FFT 4 – Resilient overlay platform floor system

- proprietary platform system inclusive of resilient layer greater than or equal to  $16\text{ kg/m}^2$  mass per unit area
- no services to be installed in floor system\*

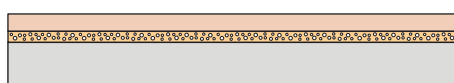

### FFT 5 – Resilient overlay shallow platform floor system

- 9mm (min) t & g flooring board
- resilient layer pre-bonded to flooring board
- no services to be installed in floor system\*

\* Additional under floor heating layers may be incorporated within FFT4 and FFT5 provided the complete build-up, using all components, has been tested to give a minimum laboratory performance of  $rd\Delta L_w = 17\text{dB}$  - see Appendix D.

## Appendix A1 – Additional Guidance

- Construct the internal wall directly off core floor with the floating floor treatment (FFT) or screed installed around the internal walls, provided:
  - the 5mm (min) resilient flanking strip or isolating edge strip, as appropriate for the Robust Detail adopted, is correctly installed to all perimeters of the FFT or screed to isolate the floor from all the walls and skirtings
- Construct the internal wall off the floating floor treatment flooring board or screed, provided:
  - the floating floor treatment is installed in accordance with the manufacturer's instructions, including the provision of additional battens to support the internal walls if necessary

### Subfloor ventilation

Where possible it would be preferable to avoid providing ventilation for the sub floor void through the separating walls.

However, where necessary, the ventilation of the sub floor void of Part E Robust Detail separating walls may be achieved through the installation of ducts through the separating wall, provided:

- the top of the duct is at least 300mm below the finished floor surface of the ground floor structure
- the number of ducts passing through the separating wall is kept to the minimum necessary.

### Radon and methane barriers

It is acceptable to install a radon or methane barrier and comply with the Robust Details. The ground floor junction detail would need to follow that described in the Robust Detail and as such the 225mm (min) clear cavity indicated in the ground floor junction to masonry separating walls would need to be maintained. Alternatively, refer to Appendix A2.

### Ground floor junctions

5mm (min) flanking strips are recommended to isolate floating floor finishes, where provided, from walls and skirtings.

### Screed thickness

The screed thickness stated is the minimum thickness at any point and a greater thickness should be specified to take account of deviations in the finished levels of the surfaces of bases and any reinforcement provided.

Cement:sand screed should be at least 50mm to comply with BS 8204. Concrete screed is acceptable.

### Precast concrete plank separating floors with steel beams

In some situations precast concrete planks may require intermediate support by steel beams supported on masonry.

- cavity masonry separating walls must not be built off steel beams – where necessary, external cavity walls may be built off steel beams
- all voids between the steel beam and the slabs should be fully filled with grout or concrete, and
- the supports for the ceiling treatment and the ceiling lining should not come into contact with the steel beam, and
- the depth of the ceiling void from the underside of the plank should be as shown in the following diagrams and in accordance with the corresponding separating floor Robust Detail
- mineral wool quilt should be provided if shown in the following diagrams

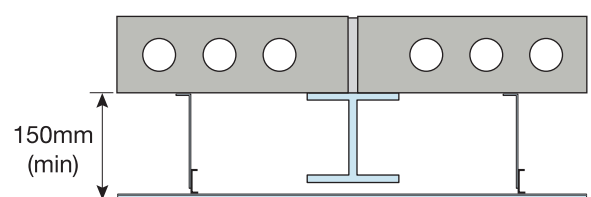
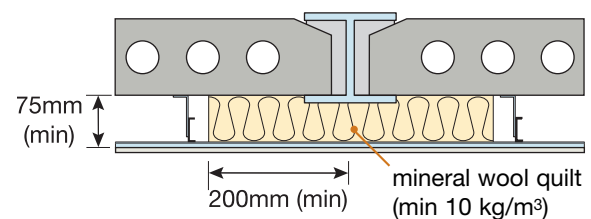
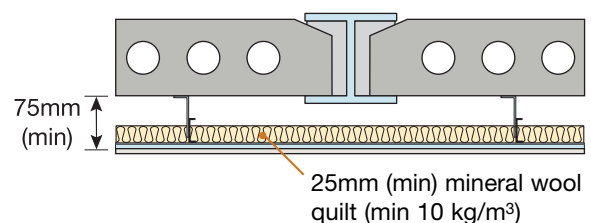
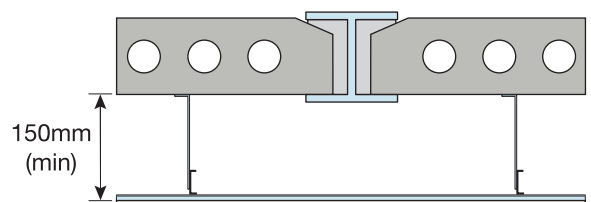

## Appendix A1 – Additional Guidance

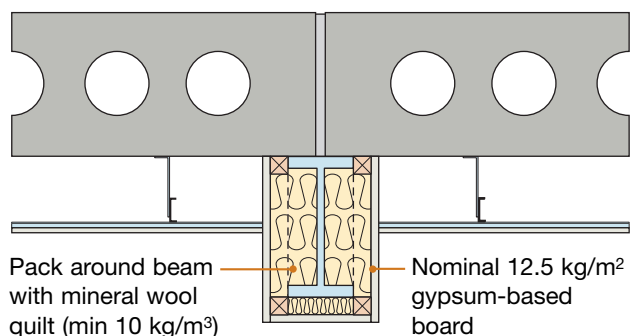

An alternative detail where two steel beams are required to support the external cavity wall is as follows:

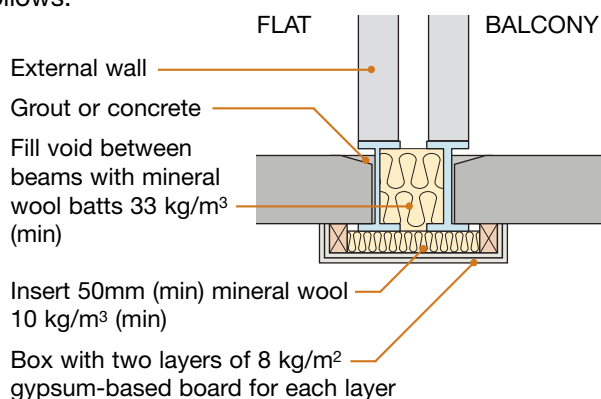

Separating walls should not be constructed off steel beams.

### Services in separating floors

#### **Downlighters or recessed lighting**

Where possible, downlighters or recessed lighting should not be built into the separating floor. If they must be built in, they should be kept to a minimum and the guidance included in the Robust Detail followed. For timber separating floors, see Appendix F also.

Particular attention should also be paid to Building Regulation Part B – Fire Safety.

#### **Other services**

Electrical and plumbing services may be installed in the separating floor. All penetrations through the ceiling lining, floor decking and flooring board should be cut carefully. The gap around the service should be carefully sealed with flexible sealant.

Where services are installed within a floating floor treatment, the manufacturer's instructions should be followed. It is acceptable to leave a gap of up to 50mm in the batten to allow services to cross at right angles.

Ducts for extract ventilation, etc. may run within the separating floor, provided the acoustic integrity is maintained.

Ducting which drops from the ceiling void needs to be enclosed in boxing of gypsum-based board of the same composition and mass per unit area as the relevant Robust Detail ceiling treatment.

It is permissible to install services within the screed of concrete floors, provided that:

- the minimum thickness and mass per unit area of the screed is maintained as detailed in the relevant Robust Detail
- the minimum cover on services is maintained
- the services do not break into or bridge the resilient layer(s). In the case of floors which also have a floating timber floor treatment (FFT), it is permissible for services to rise vertically out of the screed and through the FFT, provided the FFT flooring boards do not touch the services and the gaps around the services are sealed with a flexible sealant.

Services may be installed within a secondary ceiling lining system that is only supported from the resilient bars of a ceiling treatment, provided:

- the resilient bars can support the full load;
- the resilient bars achieve the minimum laboratory performance of Appendix E.

Particular attention should also be paid to Building Regulations Part B – Fire Safety. Secondary ceilings to timber floors may also be supported by perimeter channels.

### Underfloor heating systems in separating floors

#### **With timber floating floor treatments**

Underfloor heating may be used with timber floating floor treatments FFT1, FFT2 and FFT3. Underfloor heating may only be used with FFT4 or FFT5 provided the complete build-up, using all components, has been tested to Appendix D.

Where underfloor heating is supported by mineral wool or foil-wrapped quilt, this may be used in place of the mineral wool that is specified between the battens on certain floors. Where underfloor heating is supported on rigid insulation (e.g. polystyrene), this may be used in addition to the mineral wool specified on certain floors. If this results in the batten void being filled, a polythene layer should be included to prevent direct contact with the underside of the floating deck. On floors where no mineral wool is specified, rigid insulation may be used alone, provided it does not bridge the resilient layer by providing a connection between the structural floor and any of the floating elements.

#### **With floating screed floors**

If underfloor heating systems are required to be installed within the screed they must not penetrate through the resilient layers and must avoid bridging the screed to the slab. Where rigid insulation